

 **SENNHEISER**



**evolution**wireless 

**SKM 100**



Instruction manual

# Contents

Important safety instructions .....	2
The SKM 100 G3 radio microphone family .....	3
The frequency bank system .....	3
Areas of application .....	4
Delivery includes .....	5
Product overview .....	6
Overview of the SKM 100 G3 radio microphone .....	6
Overview of the displays .....	7
Putting the radio microphone into operation .....	8
Inserting the batteries/accupack .....	8
Charging the accupack .....	9
Changing the microphone head .....	10
Changing the color-coded protection ring .....	11
Using the radio microphone .....	12
Switching the radio microphone on/off .....	12
Deactivating the lock mode temporarily .....	14
Deactivating the RF signal .....	14
Selecting a standard display .....	15
Using the operating menu .....	16
The buttons .....	16
Overview of the operating menu .....	17
Working with the operating menu .....	18
Adjusting settings via the operating menu .....	20
The main menu "Menu" .....	20
The extended menu "Advanced Menu" .....	22
Synchronizing the radio microphone with a receiver ...	25
Synchronizing the radio microphone with the receiver – individual operation .....	25
Synchronizing radio microphones with receivers – multi-channel operation .....	25
Cleaning the radio microphone .....	26
Recommendations and tips .....	27
If a problem occurs ... ..	28
Accessories and spare parts .....	29
Specifications .....	30
Polar diagrams and frequency response curves of the microphone heads .....	31
Manufacturer Declarations .....	33
Index .....	35



An animated instruction manual can be viewed on the SKM 100 G3 product page on our website at [www.sennheiser.com](http://www.sennheiser.com).

# Important safety instructions

- Read this instruction manual.
- Keep this instruction manual. Always include this instruction manual when passing the product on to third parties.
- Heed all warnings and follow all instructions in this instruction manual.
- Use only a cloth for cleaning the product.
- Do not place the product near any heat sources such as radiators, stoves, or other devices (including amplifiers) that produce heat.
- Only use attachments/accessories specified by Sennheiser.
- Refer all servicing to qualified service personnel. Servicing is required if the product has been damaged in any way, liquid has been spilled, objects have fallen inside, the product has been exposed to rain or moisture, does not operate properly or has been dropped.
- **WARNING:** To reduce the risk of short circuits, do not use the product near water and do not expose it to rain or moisture.

## Replacement parts

When replacement parts are required, be sure the service technician uses replacement parts specified by Sennheiser or those having the same characteristics as the original part. Unauthorized substitutions may result in fire, electric shock, or other hazards.

## Intended use

Intended use of the ew 100 G3 series products includes:

- having read these instructions especially the chapter "Important safety instructions",
- using the products within the operating conditions and limitations described in this instruction manual.

"Improper use" means using the products other than as described in this instruction manual, or under operating conditions which differ from those described herein.

# The SKM 100 G3 radio microphone family

This radio microphone is part of the evolution wireless series generation 3 (ew G3). With this series, Sennheiser offers high-quality state-of-the-art RF transmission systems with a high level of operational reliability and ease of use. Transmitters and receivers permit wireless transmission with studio-quality sound.

Features of the evolution wireless 100 G3 series:

- Optimized PLL synthesizer and microprocessor technology
- HDX noise reduction system
- Pilot tone squelch control
- True diversity technology
- Switching bandwidth of 42 MHz
- Increased immunity to intermodulation and interferences in multi-channel operation
- Interchangeable microphone heads, allowing the use of different pick-up patterns and sensitivities

## The frequency bank system

The radio microphone is available in 6 UHF frequency ranges with 1,680 transmission frequencies per frequency range:

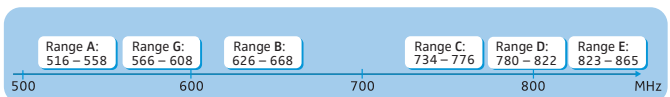

Each frequency range (A–E, G) offers 21 frequency banks with up to 12 channels each:

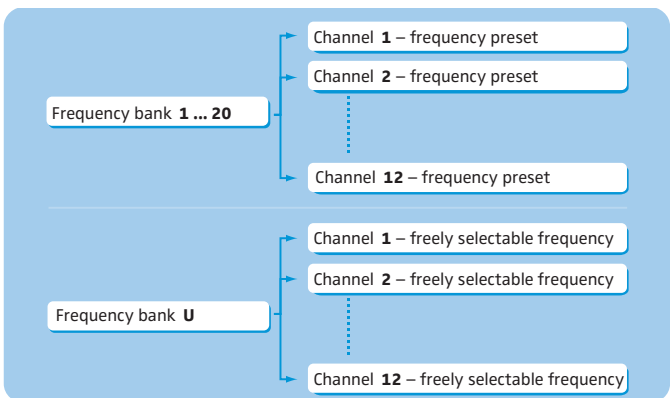

Each of the channels in the frequency banks "1" to "20" has been factory-preset to a fixed frequency (frequency preset).

The factory-preset frequencies within one frequency bank are intermodulation-free. These frequencies cannot be changed.

## The SKM 100 G3 radio microphone family

For an overview of the frequency presets, please refer to the supplied frequency information sheet. Updated versions of the frequency information sheet can be downloaded from the SKM 100 G3 product page on our website at [www.sennheiser.com](http://www.sennheiser.com).



The frequency bank "U" allows you to freely select and store frequencies. It might be that these frequencies are **not** intermodulation-free.

### Areas of application

The radio microphone can be combined with the EM 100 G3 rack-mount receiver.

The EM 100 G3 rack-mount receiver is available in the same UHF frequency ranges and is equipped with the same frequency bank system with factory-preset frequencies. This has the advantage that

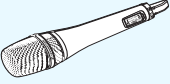
- a transmission system is ready for immediate use after switch-on,
- several transmission systems can be operated simultaneously on the preset frequencies without causing intermodulation interference.



Radio microphone	Interchangeable microphone heads	Receiver
		
SKM 100-835 G3* SKM 100-845 G3* SKM 100-865 G3*	MMD 835-1 MMD 845-1 MME 865-1	EM 100 G3

\* The name of the radio microphone is a combination of the name of the transmitter and the name of the microphone head:

Transmitter + microphone head = Name of radio microphone

SKM 100 + MMD 835-1 = SKM 100-835

Overview of the microphone heads:

Microphone head	Microphone type	Pick-up pattern
MMD 835-1	dynamic	 – cardioid
MMD 845-1	dynamic	 – super-cardioid
MME 865-1	condenser	 – super-cardioid

The name and pick-up pattern of the microphone head are printed on the sound inlet basket of the radio microphone.

## Delivery includes

The packaging contains the following items:

- 1 SKM 100 G3 radio microphone incl. microphone head
- 2 AA size batteries, 1.5 V
- 1 microphone clamp
- 1 instruction manual
- 1 frequency information sheet
- 1 RF licensing information sheet

# Product overview

## Overview of the SKM 100 G3 radio microphone

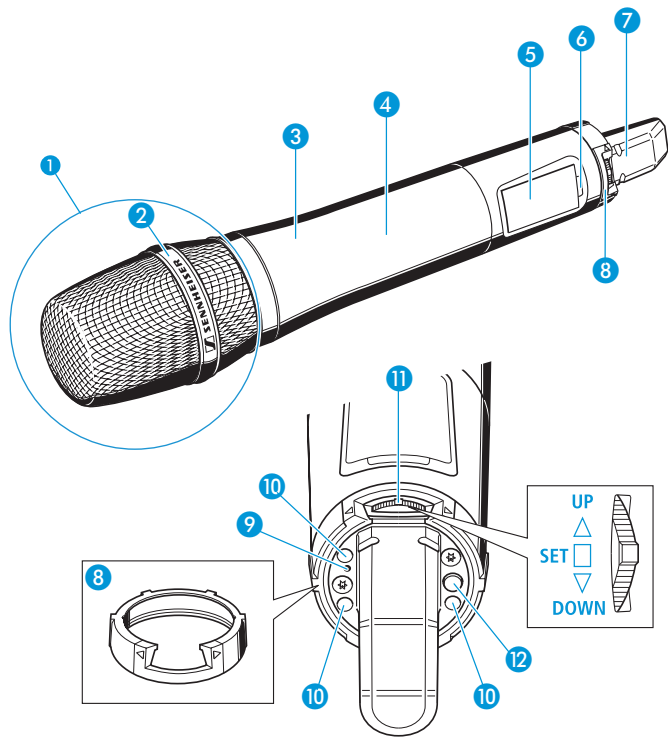





- 1 Microphone head (interchangeable)
- 2 Name and pick-up pattern of the microphone head (not visible here, see page 4)
- 3 Body of radio microphone
- 4 Battery compartment (not visible from outside)
- 5 Display panel, backlit in orange
- 6 Infra-red interface
- 7 Antenna
- 8 Color-coded protection ring; available in different colors
- 9 Operation and battery status indicator, red LED (lit = ON/flashing = LOW BATTERY)
- 10 Charging contacts
- 11 Multi-function switch:  
▼ (DOWN), ▲ (UP) and ■ (SET)
- 12 ON/OFF button with ESC function (cancel)

## Overview of the displays

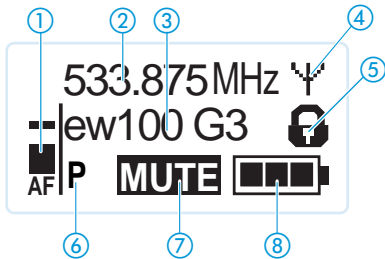
After switch-on, the radio microphone displays the standard display “**Frequency/Name**”. For further illustrations and examples of the different standard displays, refer to page 15.

The display backlighting is automatically reduced after approx. 20 seconds.

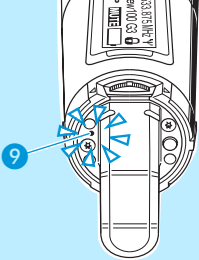

Display	Meaning
① Audio level “AF”	Modulation of the radio microphone with peak hold function
② Frequency	Current transmission frequency
③ Name	Freely selectable name of the transmitter
④ Transmission icon	RF signal is being transmitted
⑤ Lock mode icon	Lock mode is activated
⑥ “P” (pilot tone)	Pilot tone transmission is activated
⑦ “MUTE”	Audio signal is muted
⑧ Battery status	Charge status:  approx. 100%  approx. 70%  approx. 30%  charge status is critical, the red <b>LOW BATTERY LED ⑨</b> is flashing: 



# Putting the radio microphone into operation

## Inserting the batteries/accupack

For powering the radio microphone, you can either use two 1.5 V AA size batteries or the rechargeable Sennheiser BA 2015 accupack (see "Accessories and spare parts" on page 29).

- ▶ Unscrew the lower part of the radio microphone from the radio microphone's body 3 by turning it counter-clockwise.

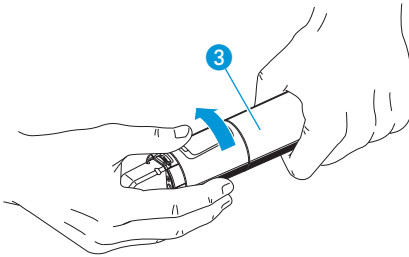

When unscrewing the radio microphone during operation, the muting function is automatically activated. "MUTE" appears on the display panel.

When screwing the lower part of the radio microphone back to the radio microphone's body, the muting is canceled. "MUTE" disappears from the display panel.

- ▶ Slide back the lower part of the radio microphone as far as it will go.

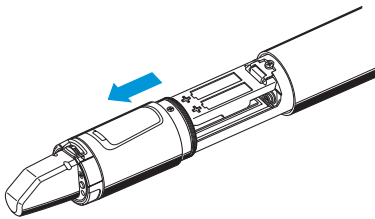

- ▶ Open the battery compartment cover 13.

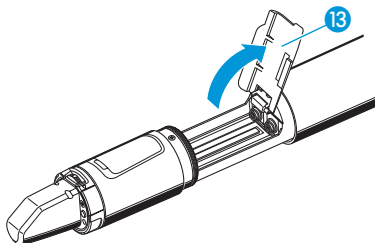

- ▶ Insert the batteries or the BA 2015 accupack as shown on the battery compartment cover. Observe correct polarity when inserting the batteries/accupack.

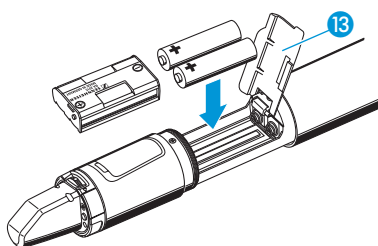

- ▶ Close the battery compartment cover 13.
- ▶ Push the battery compartment into the radio microphone's body.
- ▶ Screw the lower part of the radio microphone back to the radio microphone's body 3.

### Charging the accupack

To charge the radio microphone with the BA 2015 accupack (see "Accessories and spare parts" on page 29) installed:

- ▶ Insert the radio microphone into the LA 2 charging adapter (see "Accessories and spare parts" on page 29) until it locks into place.

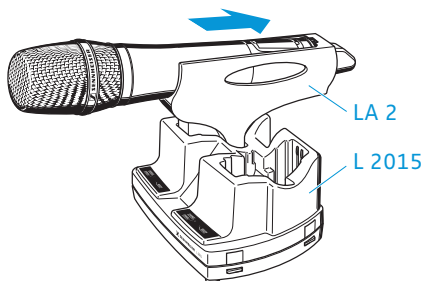

- ▶ Plug the LA 2 charging adapter with the inserted radio microphone into the L 2015 charger (see "Accessories and spare parts" on page 29).



The LA 2 charging adapter and L 2015 charger can only charge the radio microphone with the BA 2015 accupack installed. Standard batteries (primary cells) or individual rechargeable battery cells cannot be charged in this way.

## Changing the microphone head

The microphone head ① is easy to change.

- ▶ Schrauben Sie das Mikrofonmodul ① ab.

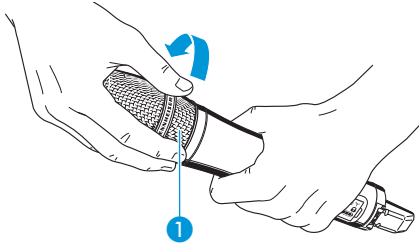

Do not touch the contacts of the radio microphone nor the contacts of the microphone head ①. The contacts can become dirty or damaged if touched.

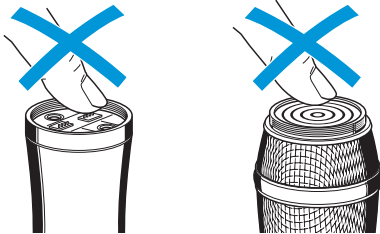

When unscrewing the microphone head ① during operation, the muting function is automatically activated. "MUTE" appears on the display panel.

When screwing the microphone head ① back to the radio microphone, the muting is canceled. "MUTE" disappears from the display panel.

- ▶ Screw the desired microphone head to the radio microphone.  
The radio microphone is operational again.

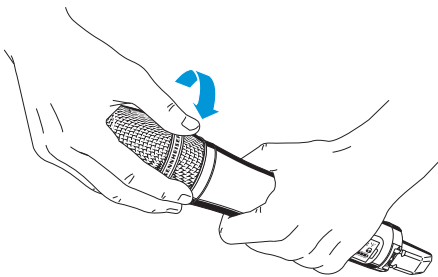

## Changing the color-coded protection ring

The color-coded protection ring 8 prevents the multi-function switch from accidental operation.

Protection rings 8 in different colors are available as accessories (see "Accessories and spare parts" on page 29). The protection rings allow you to clearly identify each radio microphone.

- ▶ Remove the color-coded protection ring 8 as shown.

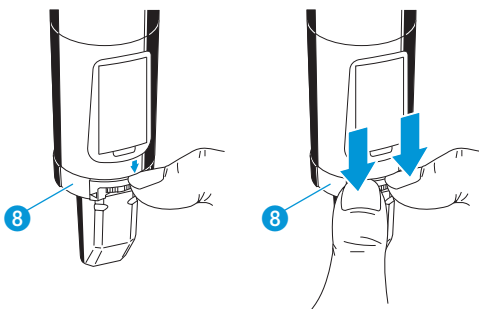

- ▶ Put on a new protection ring 8 as shown.

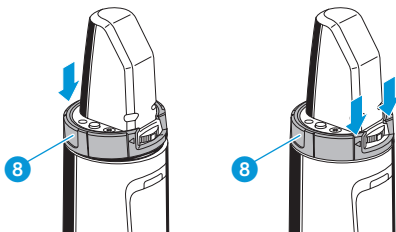

# Using the radio microphone

## CAUTION! Reduced transmission range

If you touch the antenna ⑦ of the radio microphone, the transmission range will be considerably reduced!

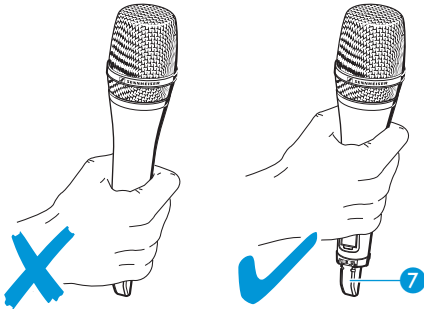

▶ Only hold the radio microphone by its body.

To establish a transmission link, proceed as follows:

1. Switch the receiver on (see the instruction manual of the receiver).
2. Switch the radio microphone on (see next section). The transmission link is established and the receiver's RF level display "RF" reacts.



It is vital to observe the notes on frequency selection on page 25.

If you cannot establish a transmission link between radio microphone and receiver, refer to the chapter "Synchronizing the radio microphone with a receiver" on page 25.

## Switching the radio microphone on/off

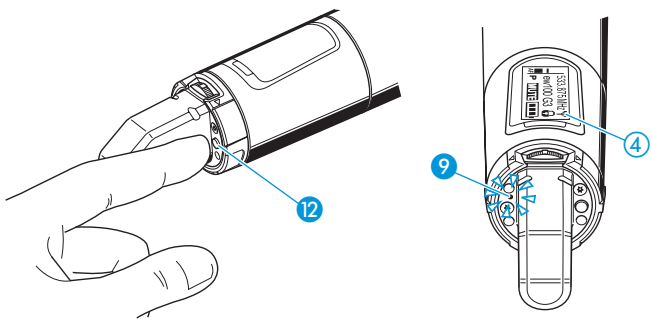

To switch the radio microphone on (online operation):

ON/OFF



▶ Briefly press the ON/OFF button ⑫.

The radio microphone transmits an RF signal.

The red ON LED ⑨ lights up. The standard display "Frequency/Name" appears on the display panel. The transmission icon ④ is displayed.



You can switch the radio microphone on and **deactivate the RF signal on switch-on**. For more information, see next section.



To switch the radio microphone **off**:

- ▶ If necessary, deactivate the lock mode (see page 14).
-  ▶ Keep the **ON/OFF** button **12** pressed until **"OFF"** appears on the display panel. The red **ON** LED **9** goes off and the display panel turns off.



When in the operating menu, pressing the **ON/OFF** button **12** will cancel your entry (ESC function) and return you to the current standard display.



To switch the radio microphone on and to **deactivate the RF signal on switch-on** (offline operation):

-  ▶ Keep the **ON/OFF** button pressed until **"RF Mute On?"** appears on the display panel.
-  ▶ Press the multi-function switch. The transmission frequency is displayed but the radio microphone does not transmit an RF signal. The transmission icon **4** is not displayed.



Use this function to save battery power or to prepare a radio microphone for use during live operation without causing interference to existing transmission links.



To **activate** the **RF signal**:

-  ▶ Briefly press the **ON/OFF** button. **"RF Mute Off?"** appears on the display panel.
-  ▶ Press the multi-function switch. The transmission icon **4** is displayed again.

## Deactivating the lock mode temporarily

You can activate or deactivate the automatic lock mode via the “Auto Lock” menu item (see page 22).

If the lock mode is activated, you have to temporarily deactivate it in order to be able to operate the radio microphone:

-  ▶ Press the multi-function switch.  
“Locked” appears on the display panel.
-  ▶ Move the multi-function switch.  
“Unlock?” appears on the display panel.
-  ▶ Press the multi-function switch again.  
The lock mode is temporarily deactivated.  
How you are using the radio microphone determines how long the lock mode remains deactivated:

### When you are in the operating menu

The lock mode remains deactivated until you exit the operating menu.

### When one of the standard displays is shown

The lock mode is automatically activated after 10 seconds.

The lock mode icon  flashes prior to the lock mode being activated again.



## Deactivating the RF signal

### Deactivating the RF signal on switch-on

For information on deactivating the RF signal on switch-on, refer to the chapter “Switching the radio microphone on/off” on page 13.

### Deactivating the RF signal during operation

-  ▶ When one of the standard displays is shown on the display panel, briefly press the **ON/OFF** button.  
“RX Mute On?” appears on the display panel.
- ▶ Proceed as described under “Switching the radio microphone on/off” on page 13.

## Selecting a standard display



- ▶ Move the multi-function switch to select a standard display.

Contents of the display	Selectable standard display
	"Frequency/Name"
	"Frequency bank/Channel/ Frequency"
	"Name/Frequency bank/ Channel"



## Using the operating menu

A special feature of the Sennheiser ew G3 series is the consistent, intuitive menu structure of transmitters and receivers. As a result, adjustments to the settings can be made quickly – even in stressful situations, for example on stage or during a live show or presentation.





Make use of the possibility to adjust settings via the operating menu of the receiver and to transfer these settings to the radio microphone.



For more information on how to transfer settings to the radio microphone, refer to the instruction manual of your receiver. The relevant information is marked with the sync icon.

## The buttons

Button	Function of the button
Press the ON/OFF button 	<ul style="list-style-type: none"> <li>• Switches the radio microphone on and off</li> <li>• Cancels the entry and returns to the current standard display (ESC function)</li> <li>• Activates/deactivates the RF signal (special function, see page 13)</li> </ul>
Press the multi-function switch 	<ul style="list-style-type: none"> <li>• Changes from the current standard display to the operating menu</li> <li>• Calls up a menu item</li> <li>• Enters a submenu</li> <li>• Stores the settings and returns to the operating menu</li> </ul>
Move the multi-function switch 	<ul style="list-style-type: none"> <li>• Selects a standard display</li> <li>• Changes to the next/previous menu item</li> <li>• Changes the setting of a menu item</li> </ul>

## Overview of the operating menu

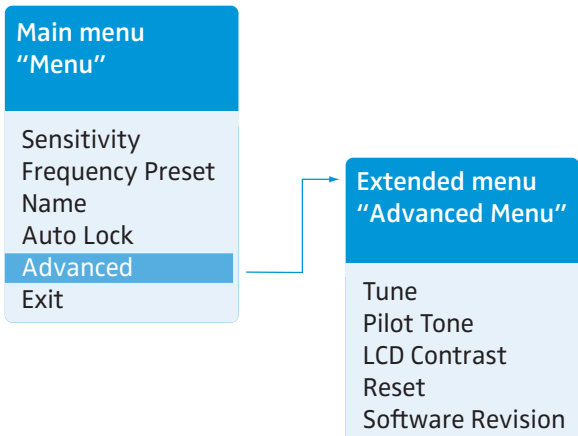

Display	Function of the menu item
<b>Main menu "Menu"</b>	
Sensitivity	Adjusts the sensitivity "AF" (see page 20)
Frequency Preset	Sets the frequency bank and the channel (see page 21)
Name	Enters the transmitter name (see page 21)
Auto Lock	Activates/deactivates the lock mode (see page 22)
Advanced	Calls up the extended menu "Advanced Menu" (see page 22)
Exit	Exits the operating menu and returns to the current standard display
<b>Extended menu "Advanced Menu"</b>	
Tune	Sets the transmission frequencies for the frequency bank "U" (see page 22)
	Sets the channel and the transmission frequency for the frequency bank "U" (see page 23)
Pilot Tone	Activates/deactivates the pilot tone transmission (see page 24)
LCD Contrast	Adjusts the contrast of the display panel (see page 24)
Reset	Resets the settings made in the operating menu (see page 24)
Software Revision	Displays the current software revision (see page 24)
Exit	Exits the extended menu "Advanced Menu" and returns to the main menu

## Working with the operating menu



If the lock mode is activated, you have to deactivate it in order to be able to work with the operating menu (see page 14).

By way of example of the "Sensitivity" menu, this section describes how to use the operating menu.

### Changing from a standard display to the operating menu



- ▶ Press the multi-function switch. The current standard display is replaced by the main menu. The last selected menu item is displayed.

### Selecting a menu item



- ▶ Move the multi-function switch to change to the "Sensitivity" menu item. The current setting of the selected menu item is displayed:

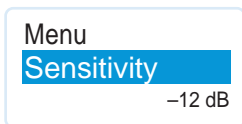

### Changing and storing settings

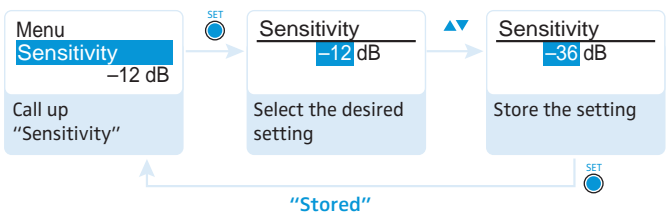

- ▶ Press the multi-function switch to call up the menu item.



- ▶ Move the multi-function switch to adjust the input sensitivity.



- ▶ Press the multi-function switch to store the setting.

### Canceling an entry



- ▶ Press the ON/OFF button to cancel the entry. The current standard display appears on the display panel.

To subsequently return to the last edited menu item:



- ▶ Press the multi-function switch repeatedly until the last edited menu item appears.

## Exiting a menu item



- ▶ Change to the "Exit" menu item.

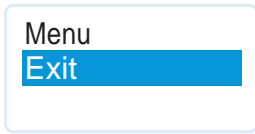

- ▶ Confirm your selection.  
You return to the next higher menu level.

To directly return to the current standard display:

ON/OFF



- ▶ Press the ON/OFF button.

# Adjusting settings via the operating menu



Make use of the possibility to adjust settings via the operating menu of your receiver and to transfer these settings to the radio microphone.



For more information, refer to the instruction manual of the receiver. The relevant information is marked with the sync icon.

## The main menu "Menu"

### Adjusting the input sensitivity – "Sensitivity"

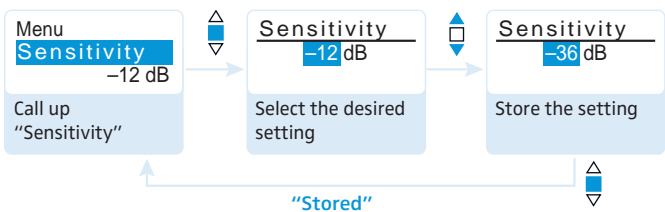

Adjustment range: 0 to –48 dB, adjustable in steps of 6 dB



The audio level display "AF" ① always indicates the audio level, even if the radio microphone is muted, e.g. allowing you to check the adjusted sensitivity before live operation.

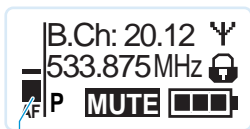

Input sensitivity is adjusted...	Effect/display
... too high	Close talking distances, speakers with loud voices or loud music passages cause overmodulation in the transmission link. The audio level display "AF" ① shows full deflection for the duration of the overmodulation.
... correctly	The audio level display "AF" ① shows full deflection only during the loudest passages.
... too low	The transmission link is undermodulated. This results in a signal with high background noise.

The following figures are a guide to the best settings:

Transmission situation	Sensitivity setting
Loud music/vocals	-48 to -18 dB
Presentations	-18 to -12 dB
Interviews	-12 to 0 dB

### Selecting the frequency bank and the channel manually – “Frequency Preset”

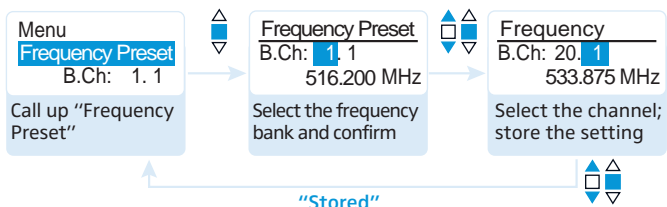

When you are in the “Frequency Preset” menu item, the RF signal is deactivated.

Overview of the frequency banks and channels:

Frequency bank	Channels	Type
“1” to “20”	up to 12 per frequency bank	System bank: frequencies are factory-preset
“U”	up to 12	User bank: frequencies are freely selectable



When setting up multi-channel systems, please observe the following:

Only the factory-preset frequencies within one frequency bank are intermodulation-free (see page 25).

Radio microphone and receiver of a transmission link have to be set to the same frequency.

- ▶ It is vital to observe the notes on frequency selection on page 25.

### Entering a name – “Name”

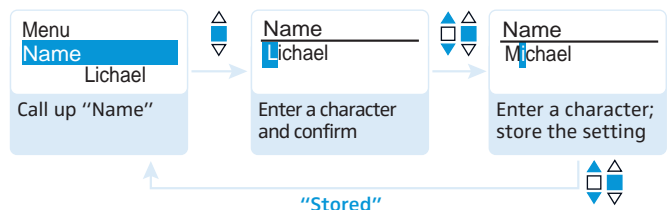



Via the “Name” menu, you can enter a freely selectable name (e.g. the name of the performer) for the radio microphone.

The name can be displayed on the standard displays **"Frequency/Name"** and **"Name/Frequency bank/Channel"**. The name can consist of up to 8 characters such as:

- letters (without pronunciation marks),
- numbers from 0 to 9,
- special characters and spaces.

To enter a name, proceed as follows:

-  ▶ Move the multi-function switch to select a character.
-  ▶ Press the multi-function switch to change to the next segment/character or to store the complete entry.

### Activating/deactivating the automatic lock mode – "Auto Lock"

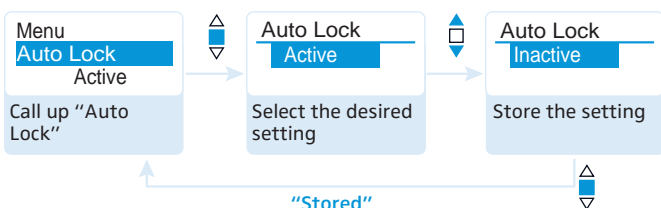

The lock mode prevents that the radio microphone is accidentally switched off or programmed during operation. The lock mode icon  on the current standard display indicates that the lock mode is activated.

-  ▶ Move the multi-function switch to select the desired setting.

For information on how to use the lock mode, refer to page 14.

## The extended menu **"Advanced Menu"**

### Setting transmission frequencies for the frequency bank **"U"** – **"Tune"**



When you have selected one of the system banks and then select the **"Tune"** menu, the radio microphone automatically switches to channel 1 of the frequency bank **"U"**. In this case, **"U.1"** briefly appears on the display panel.

Upon delivery, the channels of the frequency bank **"U"** are not assigned a transmission frequency.



When you are in the **"Tune"** menu item, the RF signal is deactivated.

Via the **"Tune"** menu item, you can set a transmission frequency to be stored in the current channel or you can select a different channel in the frequency bank **"U"** and assign this channel a transmission frequency.



It is vital to observe the notes on frequency selection on page 25

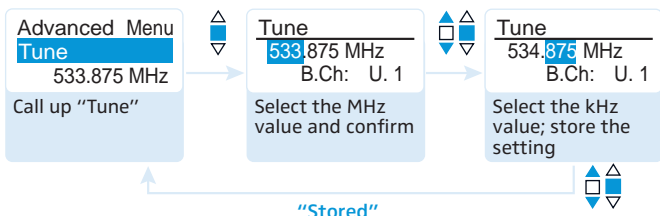

### Setting a transmission frequency for the current channel

-  ▶ Move the multi-function switch until the “Tune” menu item appears.
-  ▶ Press the multi-function switch. The frequency selection appears.





- ▶ Set the desired frequency.
-  ▶ Press the multi-function switch. Your settings are stored. You are back to the operating menu.

### Selecting a channel and assigning this channel a frequency

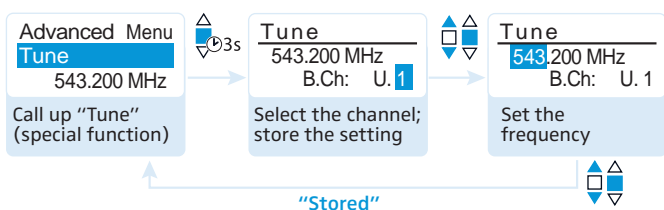
-  ▶ Move the multi-function switch until the “Tune” menu item appears.
-  ▶ Press the multi-function switch until the channel selection appears.



- ▶ Set the desired channel.
-  ▶ Press the multi-function switch. The frequency selection appears.
- ▶ Set the desired frequency.
-  ▶ Press the multi-function switch. Your settings are stored. You are back to the operating menu.



## Activating/deactivating the pilot tone transmission – “Pilot Tone”

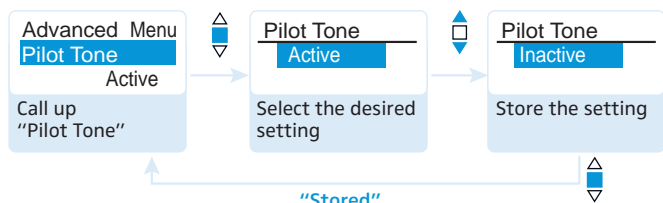

The radio microphone adds an inaudible signal, known as the pilot tone, to the transmitted signal. The receiver detects and evaluates the pilot tone.

The pilot tone supports the receiver’s squelch function (Squelch) and protects against interference due to RF signals from other devices.

Devices of the ew 100 G1 series (generation 1) do not support the pilot tone function. Therefore, please observe the following when combining a radio microphone or receiver of the ew 100 G3 series (generation 3) with devices from an earlier evolution wireless generation:

Radio microphone	Receiver	Make sure to ...
ew G3/ew G2	ew G3/ew G2	... activate the pilot tone function on both radio microphone and receiver.
ew G3	ew G1	... deactivate the pilot tone function on the ew 100 G3 radio microphone.
ew G1	ew G3	... deactivate the pilot tone function on the ew 100 G3 receiver.

## Adjusting the contrast of the display panel – “LCD Contrast”

You can adjust the contrast of the display panel in 16 steps.

## Resetting the settings made in the operating menu – “Reset”

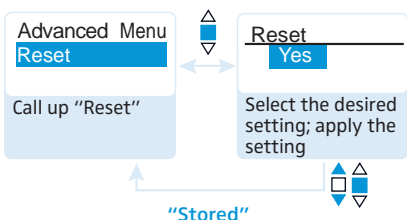

When resetting the settings made in the operating menu, only the selected settings for the pilot tone and for the frequency bank “U” remain unchanged.

For an overview of the factory-preset default settings, refer to the supplied frequency information sheet.

## Displaying the software revision – “Software Revision”

You can display the current software revision of the radio microphone.

## Synchronizing the radio microphone with a receiver

When synchronizing the radio microphone with a receiver, please observe the following:



- ▶ Only use a transmitter and a receiver from the same frequency range (see the type plate on the transmitter and the receiver).
  - ▶ Make sure that the desired frequencies are listed in the enclosed frequency information sheet.
  - ▶ Make sure that the desired frequencies are approved and legal in your country and, if necessary, apply for an operating license.
- 

### Synchronizing the radio microphone with the receiver – individual operation

Upon delivery, the radio microphone and the receiver are synchronized with each other.

If, however, you cannot establish a transmission link between radio microphone and receiver, you have to synchronize the channels of the devices.

For information on automatic synchronization of the radio microphone with the receiver (individual operation), refer to the instruction manual of the receiver. This information is marked with the **sync** icon.

Alternatively, you can set the channel on the radio microphone manually:

- ▶ Make sure that you set the radio microphone to the same frequency bank and the same channel as the receiver (see page 21).

If you still cannot establish a transmission link, refer to the chapter “If a problem occurs ...” on page 28.

### Synchronizing radio microphones with receivers – multi-channel operation

Combined with ew 100 G3 receivers, ew 100 G3 radio microphones can form transmission links that can be used in multi-channel systems.

For information on automatic synchronization of radio microphones with receivers (multi-channel operation), refer to the instruction manual of your receiver.

For more information on multi-channel operation, visit the SKM 100 G3 product page at [www.sennheiser.com](http://www.sennheiser.com).

## Cleaning the radio microphone

---

**CAUTION!** Liquids can damage the electronics of the radio microphone!

Liquids entering the housing of the device can cause a short-circuit and damage the electronics.

- ▶ Keep all liquids away from the radio microphone.

- 
- ▶ Use a cloth to clean the radio microphone from time to time.
  - ▶ Do not use any solvents or cleansing agents.

To clean the sound inlet basket of the microphone head (MMD 835-1, MMD 845-1, MME 865-1):

- ▶ Unscrew the upper sound inlet basket from the microphone head by turning it counterclockwise (see diagram).

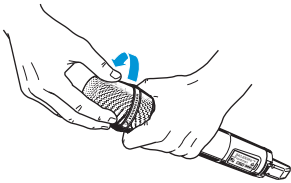

---

**CAUTION!** Liquids will damage the microphone module!  
Liquids will damage the microphone module.

- ▶ Only clean the upper sound inlet basket.

- 
- ▶ Remove the foam insert.
  - ▶ To clean the sound inlet basket:
    - Use a cloth to clean the upper sound inlet basket from the inside and outside.
    - OR
    - Scrub with a brush and rinse with clear water.
  - ▶ If necessary, clean the foam insert with a mild detergent or replace the foam insert.
  - ▶ Dry the upper sound inlet basket.
  - ▶ Dry the foam insert.
  - ▶ Reinsert the foam insert.
  - ▶ Replace the sound inlet basket on the microphone head and screw it tight.

You should also clean the contact rings of the microphone head from time to time:

- ▶ Wipe the contact rings of the microphone head with a cloth.

## Recommendations and tips

### ... for optimum sound

- Hold the radio microphone in the middle of the microphone body. Holding it close to the sound inlet basket will influence the radio microphone's pick-up pattern.
- You can vary the bass reproduction by increasing/decreasing the talking distance.
- For best results, make sure that the sensitivity is correctly adjusted.

### ... for optimum reception

- Transmission range depends to a large extent on location and can vary from about 10 m to about 150 m. There should be a "free line of sight" between transmitting and receiving antennas.
- To avoid overloading the receiver, observe a minimum distance of 5 m between transmitting and receiving antennas.
- Only hold the radio microphone by its body. If you touch the antenna of the radio microphone, the transmission range will be considerably reduced.

### ... for multi-channel operation

- For multi-channel operation, you should only use the channels within one frequency bank. Each of the frequency banks "1" to "20" accommodates factory-preset frequencies which are intermodulation-free.
- When using several transmitters simultaneously, interference can be avoided by maintaining a minimum distance of 20 cm between two transmitters.

## If a problem occurs ...

Problem	Possible cause	Possible solution
Radio microphone cannot be operated, "Locked" appears on the display panel	Lock mode is activated	Deactivate the lock mode (see page 14).
No operation indication	Batteries are flat or accupack is flat	Replace the batteries or recharge the accupack (see page 8).
No RF signal at the receiver	Radio microphone and receiver are not on the same channel	Set the radio microphone to the same channel as the receiver. Synchronize the radio microphone with the receiver (see page 25).
	Transmission range is exceeded	Reduce the distance between radio microphone and receiving antennas.
	RF signal is deactivated	Activate the RF signal (see page 13).
RF signal available, no audio signal, "MUTE" appears on the display panel	Receiver's squelch threshold is adjusted too high	Reduce the squelch threshold setting on the receiver.
	Radio microphone doesn't transmit a pilot tone	Activate or deactivate the pilot tone transmission (see page 24).
Audio signal has a high level of background noise or audio signal is distorted	Radio microphone's sensitivity is adjusted too low/ too high	Adjust the input sensitivity (see page 20).

If a problem occurs that is not listed in the above table or if the problem cannot be solved with the proposed solutions, please contact your local Sennheiser partner for assistance.

To find a Sennheiser partner in your country, search at [www.sennheiser.com](http://www.sennheiser.com) under "Service & Support".

# Accessories and spare parts

The following accessories are available from your specialist dealer:

## Cat. No. Product name and description

009950 BA 2015 accupack

009828 L 2015 charger

503162 LA 2 charging adapter

503168 CC 3 system case

004839 MZW 1 wind and pop shield

002155 MZQ 1 microphone clamp

### Microphone heads

502577 MMD 935-1 microphone head, dynamic, cardioid

502579 MMD 945-1 microphone head, dynamic, super-cardioid

502575 MMD 835-1 microphone head, dynamic, cardioid

502576 MMD 845-1 microphone head, dynamic, super-cardioid

501581 MME 865-1 microphone head, condenser, super-cardioid

502582 MMK 965-1 BK microphone head, color black externally polarized dual diaphragm condenser microphone, cardioid/super-cardioid (switchable)

502583 MMK 965-1 BL microphone head, color blue externally polarized dual diaphragm condenser microphone, cardioid/super-cardioid (switchable)

502584 MMK 965-1 NI microphone head, color nickel externally polarized dual diaphragm condenser microphone, cardioid/super-cardioid (switchable)

# Specifications

## RF characteristics

Modulation	wideband FM
Frequency ranges	516–558, 566–608, 626–668, 734–776, 780–822, 823–865 MHz (A–E, G, see page 3)
Transmission frequencies	1,680 frequencies, tune-able in steps of 25 kHz  20 frequency banks, each with up to 12 factory-preset channels  1 frequency bank with up to 12 user program-mable channels
Switching bandwidth	42 MHz
Nominal/peak deviation	$\pm 24$ kHz/ $\pm 48$ kHz
Frequency stability	$\leq \pm 15$ ppm
RF output power at 50 $\Omega$	typ. 30 mW
Pilot tone squelch	can be switched off

## AF characteristics

Compander system	Sennheiser <a href="#">HDX</a>
AF frequency response	80–18,000 Hz
Signal-to-noise ratio (1 mV, peak deviation)	$\geq 110$ dBA
THD	$\leq 0.9\%$
Adjustment range of input sensitivity	48 dB, adjustable in 6-dB steps

## Overall device

Temperature range	$-10^{\circ}\text{C}$ to $+55^{\circ}\text{C}$
Power supply	2 AA size batteries, 1.5 V or BA 2015 accupack
Nominal voltage	2.4 V $\approx$
Current consumption:	
• at nominal voltage	typ. 180 mA (30 mW)
• with switched-off radio microphone	$\leq 25$ $\mu\text{A}$
Operating time	typ. 8 hrs
Dimensions	approx. $\varnothing$ 50 x 265 mm
Weight (incl. batteries)	approx. 450 g

In compliance with

Europe CE	EMC	EN 301489-1/-9
	Radio	EN 300422-1/-2
	Safety	EN 60065
		EN 62311 (SAR)

Approved by

Canada	Industry Canada RSS 123 IC: 2099A-G3SKMEM limited to 806 MHz
USA	FCC-Part 74 FCC-ID: DMO G3SKMEM limited to 698 MHz

Microphone heads

	MMD 835-1	MMD 845-1	MME 865-1
Microphone type	dynamic	dynamic	condenser
Sensitivity	2.1 mV/Pa	1.6 mV/Pa	1.6 mV/Pa
Pick-up pattern	cardioid	super-cardioid	super-cardioid
Max. SPL	154 dB SPL	154 dB SPL	152 dB SPL

Polar diagrams and frequency response curves of the microphone heads

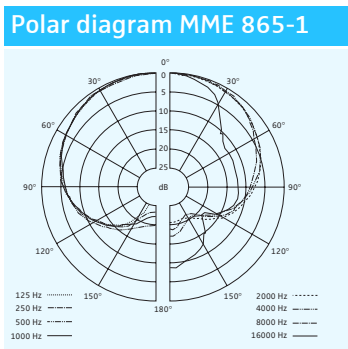
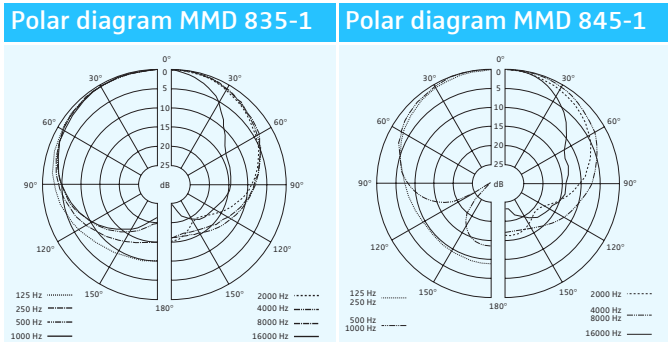



Frequency response curve MMD 835-1

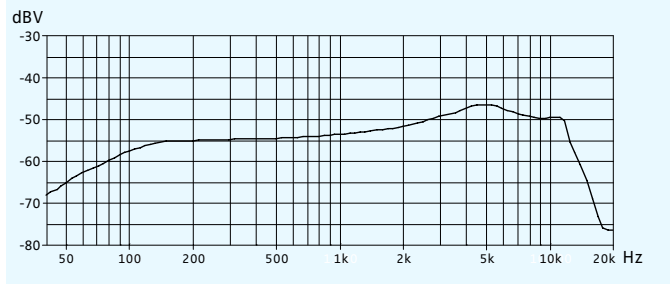

Frequency response curve MMD 845-1

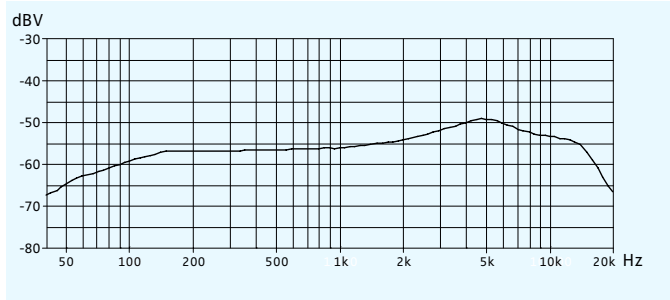

Frequency response curve MME 865-1

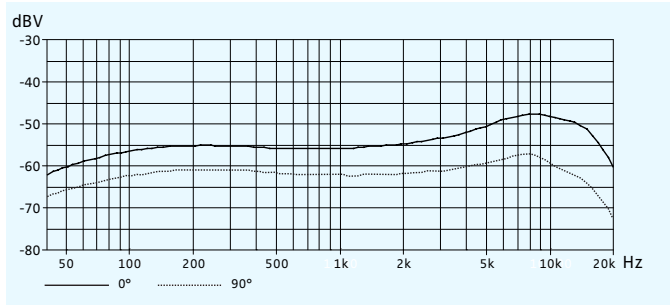

# Manufacturer Declarations

## Warranty

Sennheiser electronic GmbH & Co. KG gives a warranty of 24 months on this product.

For the current warranty conditions, please visit our web site at [www.sennheiser.com](http://www.sennheiser.com) or contact your Sennheiser partner.

## In compliance with the following requirements

- RoHS Directive (2002/95/EC)
- WEEE Directive (2002/96/EC)



Please dispose of the radio microphone at the end of its operational lifetime by taking it to your local collection point or recycling center for such equipment.

- Battery Directive (2006/66/EC)



The supplied batteries or rechargeable batteries can be recycled. Please dispose of them as special waste or return them to your specialist dealer. In order to protect the environment, only dispose of exhausted batteries.

## CE Declaration of Conformity

- **CE 0682**
- R&TTE Directive (1999/5/CE)  
The declaration is available at [www.sennheiser.com](http://www.sennheiser.com).  
Before putting the device into operation, please observe the respective country-specific regulations.

## Statements regarding FCC and Industry Canada

This device complies with Part 15 of the FCC Rules and with RSS-210 of Industry Canada. Operation is subject to the following two conditions: (1) this device may not cause harmful interference, and (2) this device must accept any interference received, including interference that may cause undesired operation.

This equipment has been tested and found to comply with the limits for a Class B digital device, pursuant to Part 15 of the FCC Rules. These limits are designed to provide reasonable protection against harmful interference in a residential installation. This equipment generates, uses and can radiate radio frequency energy and, if not installed and used in accordance with the instructions, may cause harmful interference to radio communications. However, there is no guarantee that interference will not occur in a particular installation. If this equipment does cause harmful interference to radio or television reception, which can be determined by turning the equipment off and on, the user is encouraged to try to correct the interference by one or more of the following measures:

## Manufacturer Declarations

- Reorient or relocate the receiving antenna.
- Increase the separation between the equipment and receiver.
- Connect the equipment into an outlet on a circuit different from that to which the receiver is connected.
- Consult the dealer or an experienced radio/TV technician for help.

This class B digital device complies with the Canadian ICES-003.

Changes or modifications made to this equipment not expressly approved by Sennheiser electronic Corp. may void the FCC authorization to operate this equipment.

Before putting the device into operation, please observe the respective country-specific regulations!

# Index

## Accupack

- charging 9
- inserting 8

## Activating/deactivating

- lock mode (Auto Lock) 22
- pilot tone 24

## Adjusting

- contrast (LCD Contrast) 24
- input sensitivity (Sensitivity) 20

## Advanced Menu (extended menu)

- settings 22

## AF (audio level) 7

## Auto Lock (activating/deactivating the lock mode) 22

## Batteries, inserting 8

## Buttons (function of the ~) 16

## Channel

- assigning a frequency 23
- overview 3
- selecting (Frequency Preset) 21
- selecting (Tune) 22

## Charging

- accupack 9
- battery status display 7

## Cleaning (radio microphone) 27

## Color-coded protection ring, changing 11

## Deactivating

- lock mode temporarily 14

## Displays

- adjusting the contrast (LCD Contrast) 24
- charge status 7
- overview 7
- standard displays 15

## Factory default settings (resetting the settings in the operating menu) 24

## Frequency

- preset frequencies 3
- ~ ranges 3
- selecting ~ presets 21
- setting the transmission ~ 22

## Frequency bank

- overview 3
- selecting (Frequency Preset) 21
- ~ system 3

## Frequency Preset (selecting a frequency bank/channel) 21

## Infra-red transmission 26

## Inserting (batteries/accupack) 8

## LCD Contrast (contrast of the display panel) 24

**Lock mode**

- activating/deactivating (Auto Lock) 22
- deactivating temporarily 14

**Locked (lock mode activated) 14**

**Menu (main menu)**

- overview 17
- settings 20

**Microphone heads**

- changing 10
- changing the color-coded protection ring 11
- overview 4
- pick-up patterns 4
- polar diagrams/frequency response curves 32
- suitable ~ 4

**Modulation (input sensitivity/adjusting the sensitivity) 20**

**Multi-channel operation 26**

**Name (entering a name) 21**

**Offline operation (RF signal deactivated) 13**

**Online operation (RF signal activated) 12**

**Pilot tone**

- activating/deactivating 24
- transmission 24

**Radio microphone**

- cleaning 27
- resetting (Reset) 24
- switching on/off 12
- synchronizing with receiver 26

**Reset (resetting the settings in the operating menu) 24**

**RF Mute On/Off (activating/deactivating the RF signal) 13**

**RF signal**

- activating (online operation) 12
- deactivating (during operation) 14
- deactivating (offline operation) 13

**Selecting (Tune) 23**

**Sensitivity (adjusting the input sensitivity) 20**

**Setting**

- transmission frequency (Tune) 22

**Setting up**

- multi-channel system 26
- transmission link 26

**Software Revision (displaying the software revision) 25**

**Synchronizing (radio microphone/receiver) 26**

**Transmission frequency**

- selecting (Frequency Preset) 21
- setting (Tune) 22

**Transmission link, establishing 26**

**Transmission power, optimizing 28**

**Troubleshooting 29**

**Tune (setting a transmission frequency) 22**

**Unlock (deactivating the lock mode) 14**

**Using**

- operating menu 18
- radio microphone 12

Sennheiser electronic GmbH & Co. KG  
Am Labor 1, 30900 Wedemark, Germany  
[www.sennheiser.com](http://www.sennheiser.com)

Printed in Germany  
Publ. 01/09  
529671/A01